



SERIES AP 30, 35 & 36

1/4 INCH DIAPHRAGM VALVE

Springless – manual and pneumatic (NC & NO)

- Replaceable seat
- Stainless steel 316L VAR secondary remelt or Ni-Cr-Mo alloy construction
- Operating pressures from 125 psig (9 bar) to 3,000 psig (207 bar)
- LOTO and indicating switch options
- Flow capacity 0.23 to 0.29 C_v
- Surface finish 15 Ra max/10 Ra avg (10, 7 & 5 Ra max options)
- FA option 1.125 inch C-seal
- Constant bleed option 5, 8 and 15 slpm of N₂ @ 80 psig (5.5 bar) refer to PN 430
- Multi-port options available (refer to page 4)
- Two step pneumatic valve option: dual operation – metered or full open
- Installation and operating instructions available at www.aptech-online.com in the Tech Briefs section

Manual valves

	PSIG / BAR		
	250 / 17	300 / 21	3,000 / 207
AP 3600 – Round knob, multi-turn			●
AP 3625 – Lever valve, 1/4 turn – LOTO, PL 225 optional – Lever position indicates valve status			●
AP 3625FA – 1.125 inch C-seal		●	
AP 3650 – Round knob, 1/4 turn – Open/closed status indication window – Switch option for remote monitoring			●
AP 3652 – Round knob, 1/4 turn – Open/closed status indication window – Unique design combines scalloped round knob with raised rectangular section	●		
AP 3657 and 3659 – Round knob, 1/4 turn – Pull, then turn to open – operational safety feature – Open/closed status indication window – LOTO – integral standard feature	●		●
	AP 3659		AP 3657

Pneumatic valves, normally closed (NC)

	PSIG / BAR		
	125 / 9	145 / 10	300 / 21
AP 3000 and 3002 – Switch option for remote monitoring			●
AP 3540		●	
AP 3540VS, 3542, 3545FA	●		
AP 3550 – Switch option for remote monitoring			●
AP 3571 – Dual mode – metered or full open	●		

Pneumatic valve, normally open (NO)

	PSIG / BAR		
	125 / 9	250 / 17	3,000 / 207
AP 3080 – Switch option for remote monitoring			●
AP 3580 – Switch option for remote monitoring		●	
AP 3585FA	●		

All specifications subject to change without notice.

THE ULTIMATE IN ULTRACLEAN TECHNOLOGY

Engineering Data — Manual valves

Operating pressure	AP 3652, 3659 AP 3625FA AP 3600, 3625, 3650, 3657	Vacuum to 250 psig (17 bar) Vacuum to 300 psig (21 bar) Vacuum to 3,000 psig (207 bar)
Flow coefficient (C_v)	AP 3600, 3625, 3650, 3652, 3657, 3659	0.29 ($X_T = 0.6$)

Engineering Data — Pneumatic valves

Operating pressure	AP 3540VS, 3542, 3571, 3545, 3585 AP 3540 AP 3580 AP 3550 AP 3000, 3002, 3080	Vacuum to 125 psig (9 bar) Vacuum to 145 psig (10 bar) Vacuum to 250 psig (17 bar) Vacuum to 300 psig (21 bar) Vacuum to 3,000 psig (207 bar)
Flow coefficient (C_v)	AP 3000, 3080 AP 3002 AP 3540, 3542, 3545, 3550, 3571, AP 3580, 3585	0.23 ($X_T = 0.5$) 0.28 ($X_T = 0.5$) 0.29 ($X_T = 0.6$) 0.29 ($X_T = 0.6$)
Status	AP 3000, 3002, 3540, 3542, 3545 AP 3550, 3571 AP 3080, 3580, 3585	Normally closed (NC) Normally closed (NC) Normally open (NO)
Actuation pressure	AP 3000, 3002, 3540, 3550 AP 3080, 3545, 3571, 3580, 3585 AP 3542	70 to 110 psig (5 to 8 bar) 70 to 110 psig (5 to 8 bar) 60 to 110 psig (4 to 8 bar)
Actuation port	AP 3000, 3002, 3080, 3540, 3545, AP 3580, 3585 AP 3542 AP 3550, 3571	1/8 NPT, top port 1/8 NPT, top port M5 top port M5 side port

Engineering Data — Other parameters all valves

Inlet and outlet connectors	1/4 and 3/8 inch face seal or tube weld, FA 1.125 inch C-seal
Internal volume	0.06 in ³ (1.07 cm ³)
Operating temperature	-40° to +160° F (-40° to 71° C)
Surface finish	15 µin. Ra max / 10 µin. Ra avg. (0.4/0.25 µm) standard; 10 µin (0.25 µm); 7 µin (0.18 µm); and 5 µin (0.13 µm) Ra max optional
Proof pressure	1.5 times operating pressure
Burst pressure	3 times operating pressure
Inboard leakage	2 x 10 ⁻¹⁰ sccs
Outboard leakage	2 x 10 ⁻⁹ sccs He
Leakage across seat	4 x 10 ⁻⁸ sccs He

Engineering Data — Wetted materials all valves

	S	H (not available FA)
Body	SS 316L secondary remelt	Ni-Cr-Mo alloy / UNS N06022
Finish	Electropolished and passivated	Electropolished
Diaphragm	Ni-Co Alloy / UNS R30003	Ni-Co Alloy / UNS R30003
Seat	PCTFE (Polyimide optional)	PCTFE

AP 3571 — Metered flow range tolerance at 80 psig N₂ inlet, 0 psig outlet

10 to 20 slpm	+/- 6 slpm
21 to 50 slpm	+/- 10 slpm
51 to 100 slpm	+/- 15 slpm
101 to 200 slpm	+/- 20 slpm

All specifications subject to change without notice.

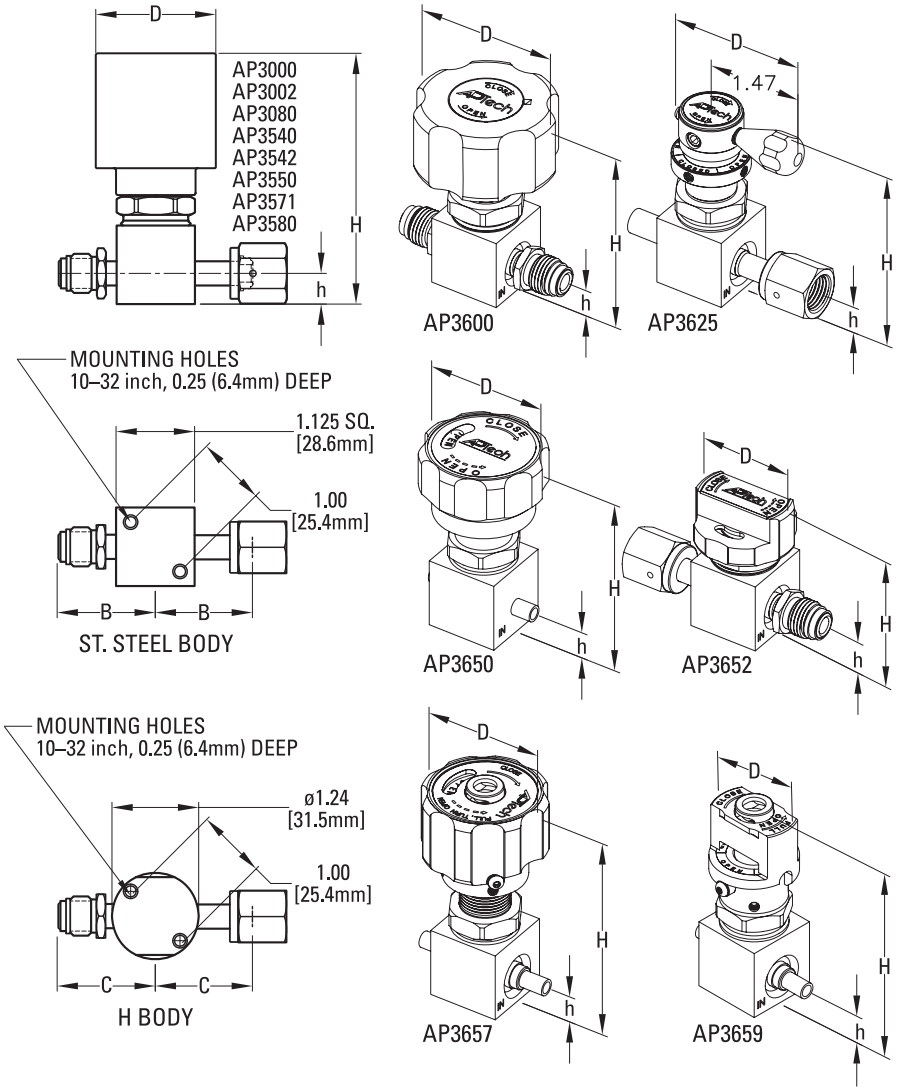

- Metric dimensions are for reference only.
- Height of the valve (H) is an approximate value.
- All specifications subject to change without notice.
- All manual valves are shown in open position.

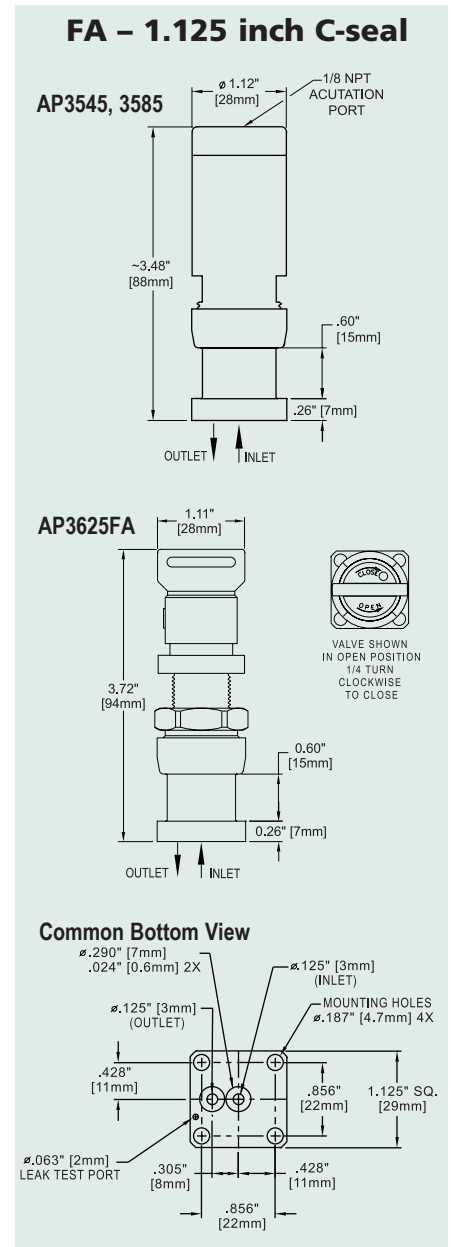

VALVE	D		H	
	inch	mm	inch	mm
AP3000	ø1.98	50.3	~4.10	104
AP3002	ø1.98	50.3	~4.10	104
AP3080	ø1.98	50.3	~4.89	124
AP3540	ø1.46	37.1	~3.49	89
AP3542	ø1.57	40.0	~2.24	57
AP3550	ø1.37	34.8	~3.28	83
AP3571	ø1.72	43.7	~3.63	92
AP3580	ø1.46	37.1	~3.17	81
AP3600	ø2.12	53.8	~3.00	76
AP3625	2.04	51.8	~2.94	75
AP3650	ø1.87	47.5	~3.02	77
AP3652	ø1.50	38.0	~2.17	55
AP3657	ø1.87	47.5	~3.60	91
AP3659	ø1.30	33.0	~3.13	80

STAINLESS STEEL BODY				
CONNECTION	B		h	
	inch	mm	inch	mm
FV4, MV4	1.390 ±.010	35.3	0.44	11.2
TW4	1.060 ±.010	26.9	0.44	11.2
FV6, MV6	1.930 ±.010	49.0	0.44	11.2
TW6	1.325 ±.010	33.7	0.44	11.2

H BODY				
CONNECTION	C		h	
	inch	mm	inch	mm
FV4, MV4	1.450 ±.010	36.8	0.44	11.2
TW4	1.080 ±.010	27.4	0.44	11.2
FV6, MV6	1.930 ±.010	49.0	0.44	11.2
TW6	1.325 ±.010	33.7	0.44	11.2

ULTRACLEAN TECHNOLOGY BACKED BY SERVICE AND SUPPORT



Top View (Mounting holes on bottom)

2 PORTS

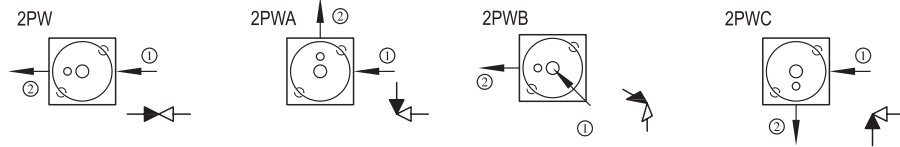

3 PORTS

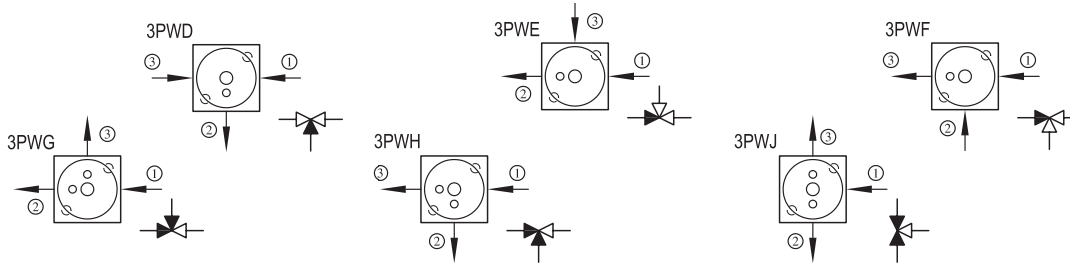

4 PORTS

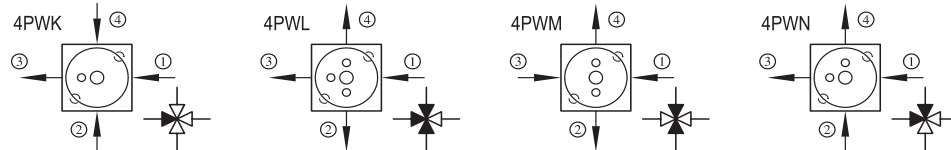

FA
1.125 in.
C-seal

○ - INLET
● - OUTLET

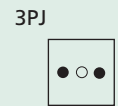
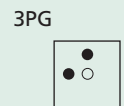
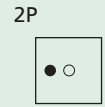

PORTING CONFIGURATIONS

- Valves are illustrated top view looking down through the valve. Mounting holes on the valve bottom are shown for reference.
- INLET (Upstream) is defined as a port connected to the region below the valve seat. It is illustrated with an arrow pointing towards the valve body or an "empty" triangle on the schematic. OUTLET (Downstream) is defined as a port connected to the region above the seat and below the diaphragm. It is illustrated with an arrow pointing away from the valve body or a "filled" triangle on the schematic.
- The traditional flow direction is INLET to OUTLET, but AP Tech valves may be employed in either flow direction.
- End connections are specified in numerical order per the diagram's numbered arrows.

CAUTION: Product selection is the sole responsibility of the user, regardless of any recommendations or suggestions made by the factory. The user shall make selections based upon their own analysis and testing with regard to function, material compatibility and product ratings. Proper installation, operation and maintenance are also required to assure safe, trouble free performance.

ORDERING INFORMATION

Sample Order Number	AP 3652S 2PW MV4 MV4		(C-seal Example: AP 3545S 2P FA)
AP 3652 Series	AP 3000, 3002, 3080, 3540, 3542 AP 3545, 3550, 3571, 3580, 3585 AP 3600, 3625, 3650, 3652, 3657, 3659		
S Material	S = Stainless steel (SS) H = Ni-Cr-Mo alloy (not available FA).		
Surface Finish Options	M = 10 µin. Ra max V = 7 µin. Ra max X = 5 µin. Ra max		
2PW Ports	2PW = 2 ports welded 3PW = 3 ports welded 4PW = 4 ports welded		
Porting Designation Option	X = Letter code for available porting option Refer to porting options above.		
MV4 MV4 Connections Inlet / Outlet or ① ② ③ ④	FV4 = 1/4 inch face seal female MV4 = 1/4 inch face seal male TW4 = 1/4 inch tube stub weld FV6 = 3/8 inch face seal female MV6 = 3/8 inch face seal male TW6 = 3/8 inch tube stub weld Refer to chart on page 3 for available connections.		
Options	1.75 = 1.75" face to face TW4, TW6 VS = Polyimide Seat P = Panel mount, manual valves* (except 3652 and FA) ISC = Indicating switch, NC* (AP 3550 and 3580 only) ISO = Indicating switch, NO* (AP 3550 and 3580 only) IS = Indicating switch* (AP 3000, 3002 and 3080 only) ISH = Indicating switch* (AP 3650 only) MXXX** = 3571 metered adjusts flow in slpm at 80 psig N ₂ FA = 1.125 inch C-seal***		
	*Refer to manual for installation information. **NOTE: Replace XXX with flow rate using 3 digits, example 50 slpm = M050. ***FA available 3625, 3545 and 3585.		

AP Tech has product options and variations which are not documented in data sheets. If you have a model number that is not defined by the ordering information, please consult the factory or your local representative.